

SWIMMING POOL AIR MANAGEMENT

DanX



Dantherm[®]
CONTROL YOUR CLIMATE

SWIMMING POOL AIR MANAGEMENT

COMFORTABLE SWIMMING IN EVERY CLIMATE

It is impossible to avoid water evaporation in swimming pool halls, however using a carefully designed ventilation solution, the relative humidity can be controlled to a comfortable level. On the basis of pool size, water temperature, air temperature, humidity and bathing activity, Dantherm's DanX can be designed to accommodate any requirement. Available with a one or two stage heat recovery system and a bespoke controls package, it is the ideal device for providing energy- and cost effective control of swimming pool hall environments – anywhere in the world.

A complete solution like the DanX offers a wide range of benefits – from greatly improved air quality and no chlorine smell in the pool room, to options for free cooling in summer and very high dehumidification capacity during winter, when condensation problems can be serious.

Developed to endure

The DanX units have been specifically designed and developed to endure the aggressive environment encountered in swimming pools.

The optional powder coating of framework and all internal surfaces, treated coils and a cross flow heat exchanger of anodized and epoxy coated aluminium also protect the DanX unit against any kind of corrosion.

Focus on cost of ownership

The DanX provides for life cycle costs in the broadest sense. Highly efficient heat recovery and low specific fan power, combined with an optimized control strategy, contribute to cost-efficient operation and significant energy savings. While durable components ensure reliable operation and long life. Ultimately, all of this results in savings in the long run and contributes to a low cost of ownership.

The solutions are ideal for private pools and hotel pools as well as municipal and commercial projects in every climate around the world – and our reference list includes a wide variety of projects. From massive water fun areas and luxurious hotel pools to spa resorts, health resorts and traditional swimming pool halls.



Highly efficient EC fans

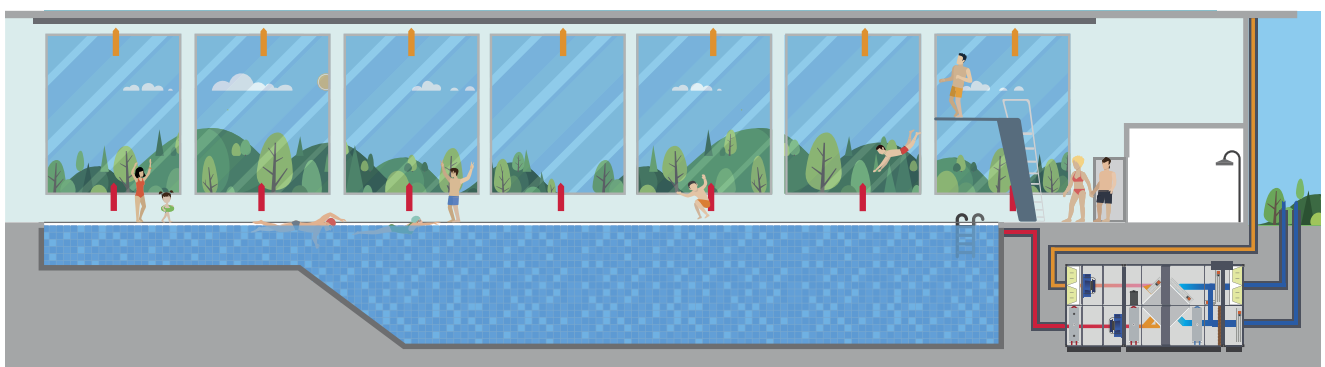

DanX XWPS with heat pump and cross flow heat exchanger

The DanX XWPS combines the best advantages of a heat pump and an outside air dehumidification system. The combination of heat pump and highly efficient cross flow heat exchanger is designed to perfectly control the humidity and indoor temperature.

Significant running cost reductions due to energy savings of up to +100%. The integrated mixing function ensures that only the exact quantity of outdoor air required to sustain comfortable conditions is supplied.



The DanX units are equipped with Heat Exchangers produced by HEATEX who participates in the Eurovent Certification programme for Heat Exchangers. Check ongoing validity of certificate on www.eurovent-certification.com or using www.certiflash.com.

DanX XWPRS with reversible heat pump and crossflow heat exchanger

DanX XWPRS is a ventilation/dehumidifier with a cross-flow heat exchanger and a reversible heat pump. This means it delivers the same functions and benefits as the XWPS. In addition, the reversible heat pump means the unit can operate with active cooling during the summer period. It is especially suitable for therapy baths with a high heat load from the hot pool water or buildings with large glass facades.

Shared benefits

Applicable for both DanX XWPS and DanX XWPRS for further energy optimization, a water cooled condenser can be integrated into the heat pump. This allows the excess heat to be transferred to the pool or the hot water supply, where it is efficiently reused.

Free cooling is also an option during summer, when the unit can add up to 100% outside air into the pool area through the integrated by-pass.



Water-cooled condenser

At night, when the evaporation rate is low and outdoor air supply is redundant, the system will switch to full recirculation, allowing the system to act wholly or partly as a dehumidifier.

DanX XWPS

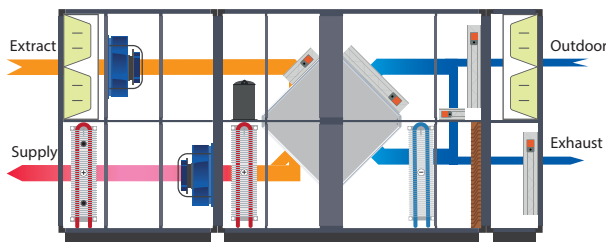

Daytime winter:
A proportion of recirculation air, with heating, 2 stage heat recovery and dehumidification with heat pump and outdoor air.

DanX XWPRS

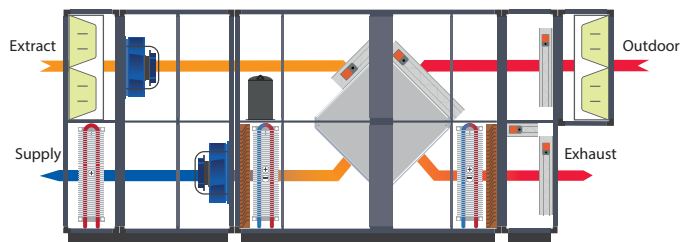

Daytime summer:
100% proportion of outdoor air. Free cooling through the by-pass and/or heat pump in cooling mode.

DanX XKS with cross flow heat exchanger

The DanX XKS is a very effective outdoor air dehumidification system with highly efficient cross flow heat exchanger. This system perfectly controls the humidity and indoor temperature while offering significant running cost reductions due to real energy savings of up to 80%. The integrated mixing function ensures that only the exact quantity of outdoor air needed is supplied – which keeps running costs at a minimum.

Free cooling is also an option during summer, when the unit can add up to 100% outdoor air into the pool area through the integrated by-pass.

For countries with high outdoor summer temperatures the system can be equipped with an additional cooling coil for further dehumidification and air cooling.

Optionally a large variation of fan types, filter qualities and coils are offered for the perfect match to the requirements.

DanX AF with heat pump

The DanX AF is a very effective heat pump dehumidification system, which perfectly controls the humidity and indoor temperature while offering significant running cost reductions. This system is the obvious choice where only limited space is available, or for pools with limited use, for instance hotel pools. Optionally it is also possible to install the unit suspended under the ceiling of the pool room.

For further energy optimization, a water cooled condenser can be integrated into the heat pump. This allows the excess heat to be transferred to the pool or the hot water supply, where it is efficiently reused.

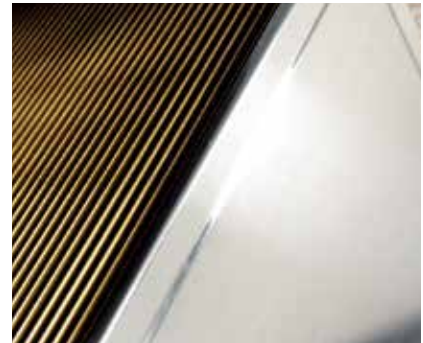

Dantherm's epoxycoated aluminum heat exchanger is not only very efficient, but also highly resistant to the aggressive swimming pool environment.



DanX XKS

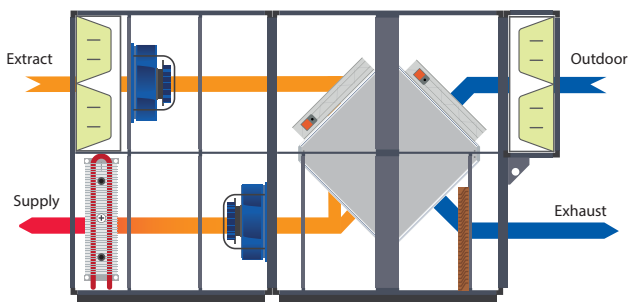

Nighttime/daytime winter:

A proportion of recirculation air with heating, 1 stage heat recovery and dehumidification with outdoor air.

DanX AF

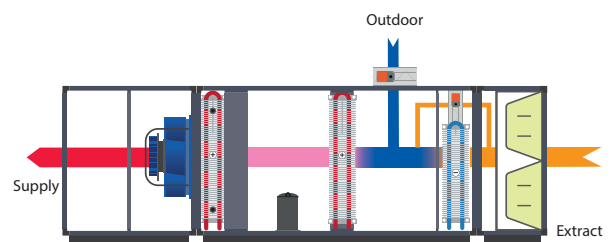

Daytime:

Recirculation with heating and dehumidification with heat pump and a proportion of outdoor air.

DanX HP with double cross flow heat exchanger and heat pump

The DanX HP combines the strengths of a heat pump system with a system that dehumidifies using outdoor air. The combined heat pump and highly effective double cross flow heat exchanger precisely regulate both humidity and temperatures in the pool room.

In addition to heat recovery exceeding 100%, the heat pump optimises dehumidification, so that the proportion of outdoor air never exceeds what is necessary to ensure comfort.

For further energy optimization, a water-cooled condenser can be integrated into the heat pump. This allows the excess heat to be transferred to the pool or the hot water supply, where it is efficiently reused.

DanX XD with double cross flow heat exchanger

The DanX XD is a very effective ventilation system that uses outdoor air to provide dehumidification using a double heat exchanger that delivers up to a 95% heat recovery. This reduces energy consumption and total operating costs. Making the unit perfect for managing humidity and temperature in the pool room.

For both DanX HP and DanX XD

The built-in mixing function takes care not to add any more outdoor air than necessary to provide a comfortable indoor climate. Free cooling is also an option during summer, when the unit can add up to 100% outdoor air into the pool area through a by-pass.

The units' compact, integrated design enables optimal installation in the technical room. Convenient top or side connections ensure easy access to ducts.



MATERIALS

- 50 mm sandwich panels
- Corrosion proof construction with powder coating internally and externally
- Epoxy coated heat exchangers
- High quality components

DanX HP

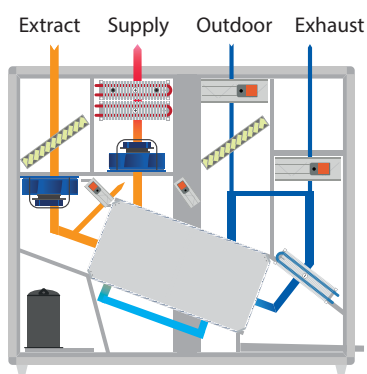

Daytime winter:

Partial recirculation with heating, large heat recovery and dehumidification with outdoor air and heat pump. To minimise pressure loss, only some of the humid return air is conducted through the heat exchanger for evaporation. If dehumidification is insufficient, the proportion of dry outdoor air is increased automatically.

DanX XD

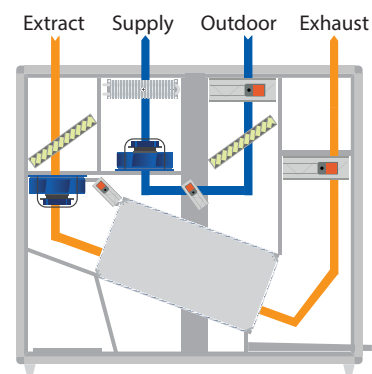

Daytime summer:

The DanX XD is running with 100% outdoor air. The reheater will normally be stopped as the temperature is high enough, after having been pre heated in the double cross flow heat exchanger. If the outdoor temperature goes further up the by pass will open to run the unit in free cooling mode.

Energy saving solutions

The DanX units are complete solutions that deliver exceptional indoor comfort using very little energy.

Ensuring a comfortable, healthy indoor climate is obviously the most important job for a system like this, as this protects both the people who use the pool and your physical assets. But operating costs are equally important, and the DanX units are extraordinarily efficient.

We have built energy savings into every detail, with all components chosen to ensure high capacity and a long service life. The system lets you add as much as 100% outdoor air. Heat exchanger that delivers up to 95% heat recovery combined with low-energy EC fan motors and optimal, high efficiency compressor ensure the lowest possible operating costs.

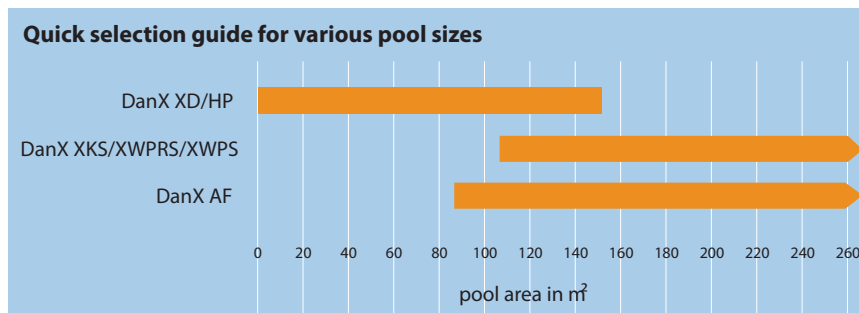

BENEFITS

- High quality and energy efficiency ensures very low LCC
- Complete solution providing ultimate comfort
- Up to 100% outdoor air with free cooling in summer
- Effective exchangers with up to 95% heat recovery efficiency
- Low-energy EC fan motors
- Effective corrosion resistance ensures long service life
- Flexible installation with a range of connection options

Product range:

DanX	Nominal air volume (m³/h)	Dehumidification¹ (kg/h)	Dehumidification² (kg/h)
HP / XD 1	1000	5 / 3	7/7
HP / XD 2	1750	9 / 6	11/11
HP / XD 3	2750	15 / 10	18/18
XWPS-XWPRS/XKS 2/4	3350	17 / 12	22/22
XWPS-XWPRS/XKS 3/6	4500	26 / 16	29/29
XWPS-XWPRS/XKS 5/10	8400	45 / 30	54/54
XWPS-XWPRS/XKS 7/14	12500	65 / 44	81/81
XWPS-XWPRS/XKS 9/18	15500	81 / 55	100/100
XWPS-XWPRS/XKS 12/24	21500	122 / 76	139/139
XWPS-XWPRS/XKS 16/32	25500	137 / 90	165/165

DanX	Nominal air volume (m³/h)	Dehumidification¹ (kg/h)
AF 3/6	4850	30
AF / AFs 5/10	7300 / 9500	47 / 59
AF / AFs 7/14	12000 / 14000	76 / 90
AF / AFs 12/24	19000 / 24000	120 / 148

¹Pool hall condition 30°C/54% r.h. 100% outdoor air @ 5°C/85% r.h.

²Max. in accordance to VDI 2089 at 30°C/54% r.h. pool hall condition.

INTELLIGENT CONTROL SYSTEM

User friendly control system

All DanX systems are supplied with a control package, which takes demand management to a new level.

Based on years of experience and on-going development, the control strategy has been optimized specifically for Dantherm swimming pool units. With automatic monitoring and control of temperature, humidity and energy consumption, you are guaranteed a balanced and comfortable indoor climate – adapted to your specific requirements.

The DanX unit is supplied ready wired and with all necessary sensors and safety devices installed.

To make it as easy as possible to establish the electrical connection between the control panel and the DanX unit, the unit can be delivered with pre-mounted plug connections.

The control system combines intuitive, hassle-free operation with extremely advanced control and programming options. The result is precise demand management – which is the secret to unprecedented low operating costs for the DanX line.

A large, easy-to-read display makes it easy to check settings and current status. And a few simple buttons let you quickly and easily programme the unit to suit your own preferences. Control over every single function is at your fingertips.



The controller has a built-in communication capability, allowing it to be integrated into a Building Management System.

Depending on the configuration, Dantherm control systems are capable of communicating with most commonly used protocols like:

- MODBUS RTU
- MODBUS TCP/IP
- BACNET MS/TP
- BACNET TCP/IP
- LON

Furthermore the Dantherm control system can be connected to your local network and can be accessed from any computer, laptop or tablet connected to this network via standard web browsers such as Internet Explorer or Google Chrome. Alarm messages can be sent to your mail address.

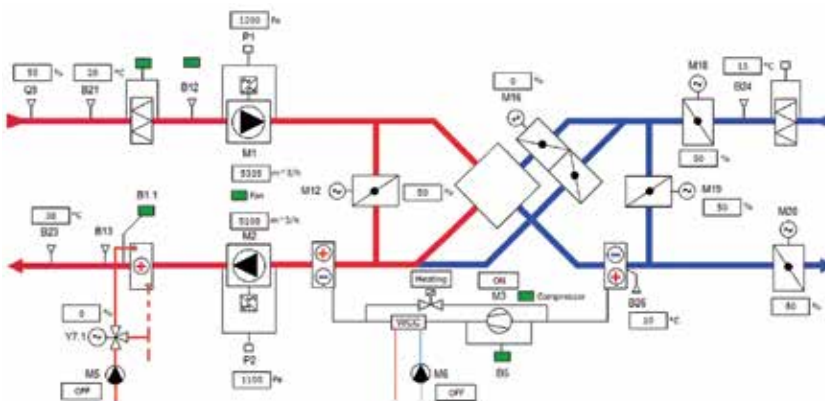

Example of flow diagram for XWPRS with MVC WEB controller

FEATURES AND ADVANTAGES

- Precise demand control
- Easy to use man/machine interface
- Dantherm control systems can communicate with most commonly used protocols
- Can be connected to your local network
- Alarm messages can be sent to your mail address
- Individually tested together with the DanX unit before delivery

ABOUT THE DANTHERM GROUP

Control your climate

The Dantherm Group is a leading provider of climate control products and solutions. The group companies have more than 60 years of experience in designing and manufacturing high-quality and energy-efficient equipment for heating, cooling, drying and ventilation for a wide range of mobile and fixed applications.

Every year, Dantherm Group uses significant resources on product development to stay in the forefront and is constantly adapting the products to changing market demands and legislation.

The Dantherm Group has a number of strong brands with well-established market positions in the mobile, pool, commercial/industrial and residential markets.

Dantherm Group customers benefit from our comprehensive knowledge base and the experience and expertise that we have gained from more than three million climate control products and solutions sold worldwide.

Global reach

The Dantherm Group is headquartered in Skive, Denmark and has its own market presence in Norway, Sweden, United Kingdom, Germany, Switzerland, Italy, Spain, Poland, Russia, China and United Arab Emirates.

In 2016 the Dantherm Group was acquired by the Swedish equity fund Procuritas Capital Investors V LP – a strong owner with the ambition to continue the development and growth of the company.

AERIAL[®]

 **calorex**

Dantherm[®]

 **MASTER**[®]
CLIMATE SOLUTIONS



RecoveryVent

Ventilation Systems

1300 137 110

info@recoveryvent.com.au

www.recoveryvent.com.au